

Chapter 9: Gravity

Newton: made revolutionary connection between the circular motion of celestial bodies and the downward falling of objects on the earth:

It is one and the same gravitational force responsible for both the apple falling from the tree and the moon orbiting around the earth.

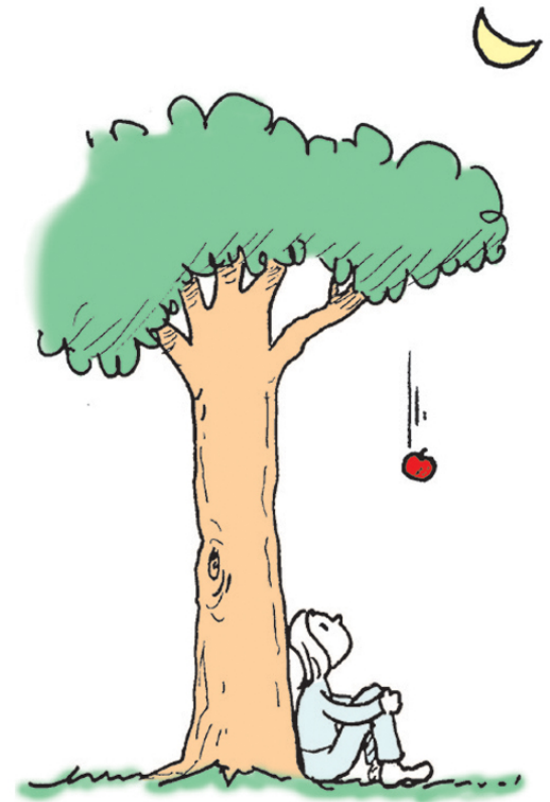

The universal law of gravity (Newton)

- Every mass m_1 attracts every other mass m_2 with a force:

$$F \sim \frac{m_1 m_2}{d^2}$$

distance between their centers

The greater (either of) the masses, the greater is the attractive force.

The closer they are to each other, the greater the force – with an inverse-square dependence.

- The constant of proportionality is called the **universal gravitational constant, G**.

$$G = 6.67 \times 10^{-11} \text{ N} \cdot \text{m}^2/\text{kg}^2 = 0.0000000000667 \text{ N m}^2/\text{kg}^2$$

Small! So gravitational forces between everyday masses at everyday distances (eg you and me) is negligible.

$$F = \frac{G m_1 m_2}{d^2}$$

Question

- If there was no earth (and no other planets/sun...), the moon would continue going in a straight line as shown by the solid arrow. The gravitational pull of the Earth draws the moon closer to it, hence it falls in an orbit around the earth, rather than directly into it.
- What would happen if the tangential speed of the moon was instead zero?

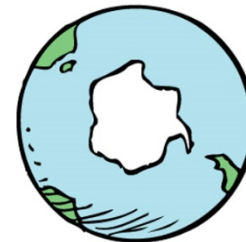
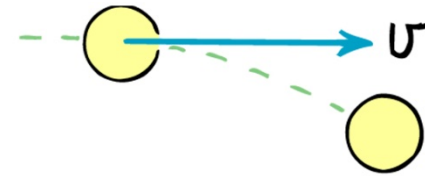

Copyright © 2006 Paul G. Hewitt, printed courtesy of Pearson Education Inc., publishing as Addison Wesley.

It would then fall straight down into the Earth....crash!

Actually it would be torn apart by tidal forces (discussed soon), as is hypothesized for the origin of planetary rings.

Distance-dependence of gravity

- Inverse-square law: $F \sim 1/d^2$

Compare with paint-spray burst out from a can: the thickness of the paint varies in the same inverse-square way i.e. if 1-layer thick at 1m, then is $\frac{1}{4}$ layers thick at 2 m etc.

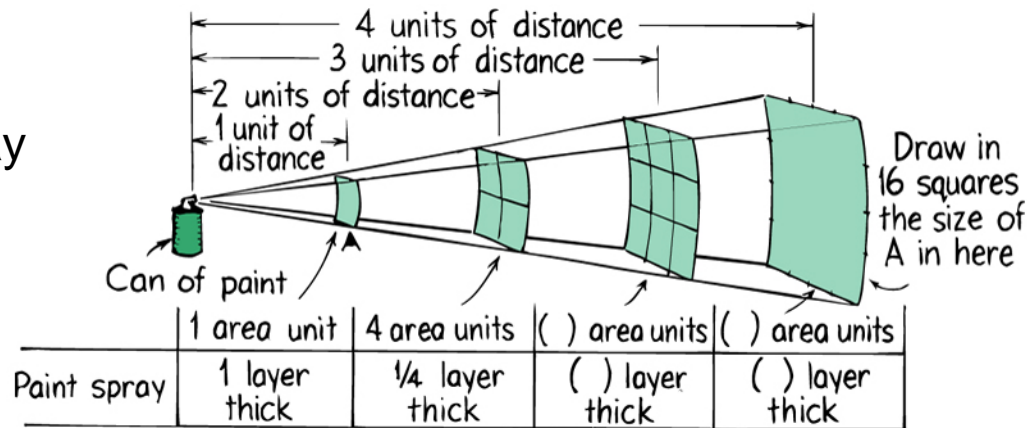

Copyright © 2006 Paul G. Hewitt, printed courtesy of Pearson Education Inc., publishing as Addison Wesley.

Mathematical origin of this: surface area of a sphere of radius R is $4\pi R^2$

Distance-dependence continued...

Notes (1) d = distance between the *center of masses* of the objects.

So when one of the objects is earth, then the relevant distance

d = radius of the earth + distance of other object from earth's surface.

$6.4 \times 10^6 \text{ m}$

(2) Even very very far from earth, its gravitational force is never actually zero, but it does decrease rapidly and forces from other more nearby objects would overwhelm the gravity force from earth.

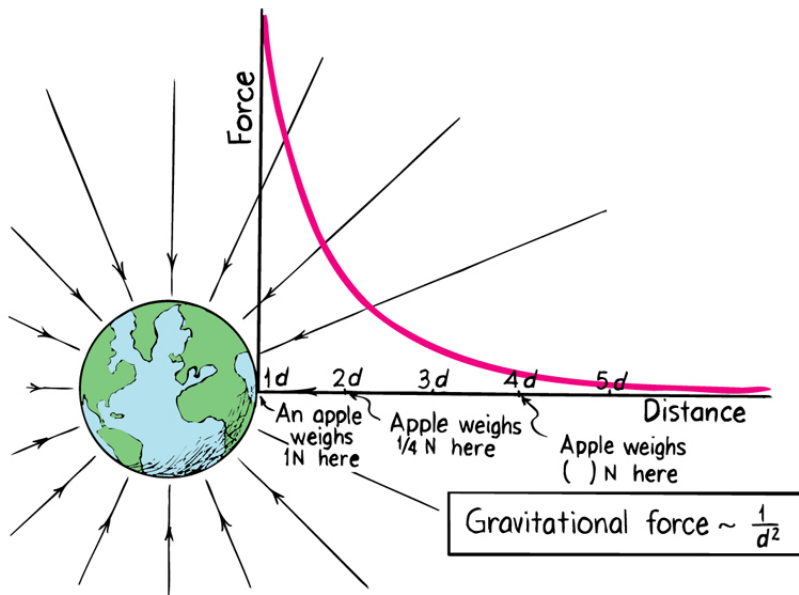

Flashvideo inv sq

Questions

(1) What is the force of earth's gravity on a 1-kg object at the surface of the earth? What do we commonly call this force?

$$F = G m_{\text{earth}} m_{1\text{kg}} / d_{\text{earth}}^2$$

$$= (6.67 \times 10^{-11}) (6 \times 10^{24} \text{ kg}) (1\text{kg}) / (6.4 \times 10^6 \text{ m})^2 = 9.8 \text{ N}$$

The force of gravity on an object is how we defined its weight.

(2) If you climbed to the top of Mount Everest (height 8850 m), how much less would you weigh? Assume you eat on the way so that your mass remains fixed.

At top of Everest, $d = 6.4 \times 10^6 + 8850 = 6.40885 \times 10^6 \text{ m}$

So, the force is $(6.4 / 6.40885)^2 = 0.997$ as much

eg. If you weigh 200-lb here, then you'll weigh 199.4-lb on Mt Everest.

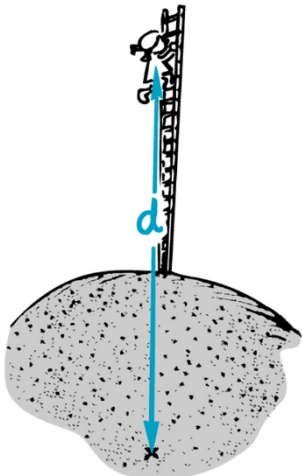

Weight and Weightlessness

- Earlier, we defined weight as force due to gravity, mg .
- But if we accelerate, we may “feel” heavier or lighter – eg. in an elevator:

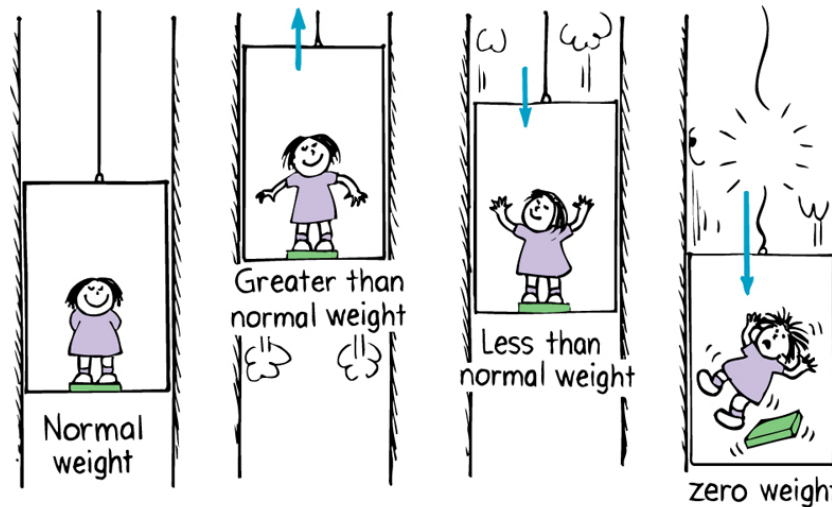

Copyright © 2006 Paul G. Hewitt, printed courtesy of Pearson Education Inc., publishing as Addison Wesley.

If the elevator accelerates upwards, any scales you are standing on will read a higher weight and you feel heavier; if accelerates downwards, they read a lower weight and you feel lighter.

The scales measure how much a spring inside is compressed – i.e. how much force it must exert to balance (or support) the force you are exerting on it.

Weight/weightless continued...

- We will now **redefine weight** to measure this instead --

Define weight = force exerted against a supporting surface or a weighing scale.

Then, you are as heavy as you feel ! (c.f. elevator again)

If the elevator is in free fall (cable broken), then your weight, defined here, is zero, since there is no support force. “Weightless”.

Gravity is still acting on you, causing downward acc. but not felt as weight.

Same weightlessness for astronaut in orbit – he still has gravity acting on him, but since every object in his shuttle (including any bathroom scale) is falling around the earth with him, he is not supported by anything, no compression in the scales etc.

Ever hear of the “vomit comet”?

Ocean Tides

- Caused by differences in the gravitational pull of the moon on the earth on opposite sides of the earth.
- Moon's pull is stronger on the side of the earth that it is closest to; weakest on the opposite side, because F decreases with distance.
- Why does this result in *two* high-tides (and two low-tides) every day? Because when the moon is **either** closest or farthest away, you get a maximum bulge:

Imagine earth to be a ball of jello.

If moon's force was equal at every point, then it all accelerates together towards moon.

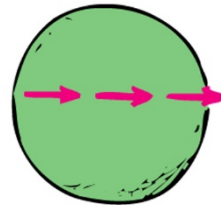

But moon's force is actually more like arrows here: so ball gets elongated – *both sides* effectively bulge.

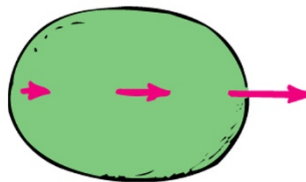

(moon over here somewhere)

Tides continued

So, *relative to the moon*, the tidal bulges remain fixed while Earth spins beneath – mostly it is the oceans that bulge out equally on opposite sides, on average nearly 1-m above.

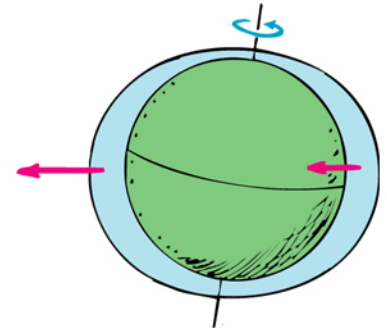

Copyright © 2006 Paul G. Hewitt, printed courtesy of Pearson Education Inc., publishing as Addison Wesley.

Note: the moon's pull on the earth is equal and opposite to the earth's gravitational pull on the moon. Centripetal force.

If earth was infinitely more massive than moon, moon would rotate about the earth.

Actually, they rotate about their CM which is a point inside earth, about $\frac{3}{4}$ the radius of the earth.

More on tides...

- Since earth spins once a day, any point on earth has two high tides and two low tides (on average, 1-m below average) a day.
- If moon was not orbiting, then the high-low tide separation would be $\frac{1}{4}$ day, ie. 6 hours.
- But since while the earth spins, the moon moves in its orbit, it turns out the moon returns to same point in the sky every 24 hours and 50 minutes – $\frac{1}{4}$ of this is what determines the high-low-tide time difference.
- This is why high tide is not at the same time every day
- Why are there no tides in lakes?
 - Because lakes are localized; no part of the lake is a lot closer to the moon than any other part, so no big differences in moon's pull in a lake, as opposed to the oceans which span the globe...

!! remember this point about differences when we come to one of the end-of-lecture questions!!

- Note also that due to the earth's tilt, the two high-tides are not equally high (see page 171 for a good illustration).

From "Classical Dynamics" (Thornton)

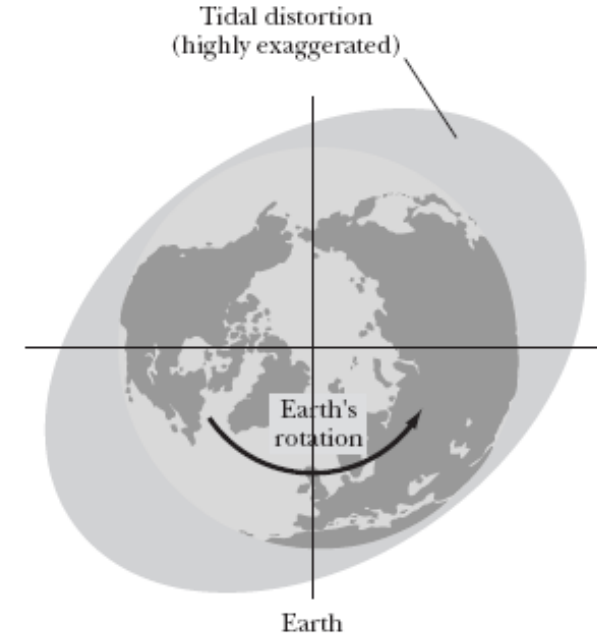
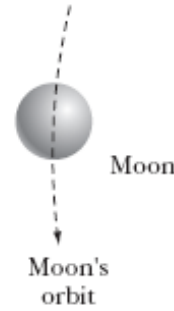
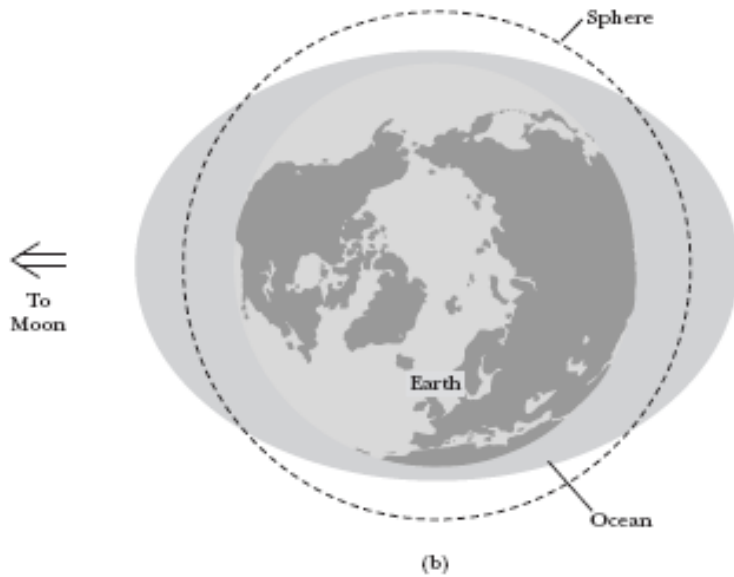
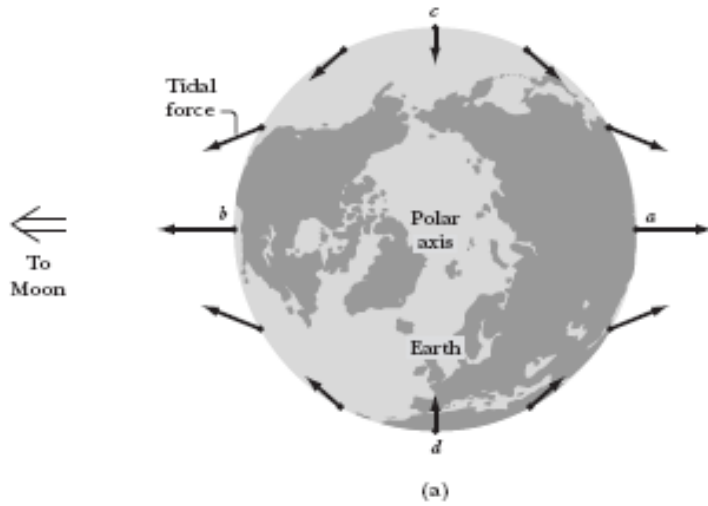

Tidal friction from Earth "dragging" oceans along as it rotates.

Other factors that affect the "ideal" tide calculation? Presence of land.

Question: How about tides due to the sun?

The sun's gravitational force on Earth is 180 times as large as that of the moon's pull on Earth. So, what about ocean tides due to the sun??

Why are these not 180 times as strong as those due to the moon?

Because tides happen due to *differences* in gravitational pulls on one side of earth c.f. other side.

Because the sun is so far away, the $1/d^2$ factor flattens out, so the difference in its F at opposite points on the earth is very small: 0.017 %

Whereas for the moon, the difference in its gravitational F at opposite points on the earth is much larger: 6.7 %

Still, 180 is a big factor in the actual size of the force – and means that despite the tiny % difference, there *are* tides due to the sun, which are about half as high as those due to the moon

($180 \times 0.017 \% = 3 \%$, which is about half of 6.7 %)

Spring vs Neap tides

- Get increased (spring) or decreased (neap) tide size due to sun and moon “collaboration”:

When sun, moon are in a line with the earth, tides due to each coincide → high-tides are higher and low tides are lower than average -- **Spring** tide (nothing to do with the season).

At full moon or new moon.

When lines to the moon and sun are at right angles, then high tide due to one occurs at low tide due to other → smaller than average high tides – **Neap** tide.

At time of half-moon.



Copyright © 2006 Paul G. Hewitt, printed courtesy of Pearson Education Inc., publishing as Addison Wesley.



Copyright © 2006 Paul G. Hewitt, printed courtesy of Pearson Education Inc., publishing as Addison Wesley.

Tides in the earth:

- Earth is molten liquid covered by a thin, solid crust → earth also experiences high and low tides! High tides are about $\frac{1}{4}$ m.
- This is why earthquakes, volcanic eruptions are more likely near a full or new moon (spring tide time).

Tides in the atmosphere:

- Air also experiences tides, but we don't feel them as we are at the bottom of the atmosphere.
- Gives rise to magnetic tides in the upper atmosphere: ionosphere has many charged particles, so tidal effects lead to electric currents that change earth's magnetic field.

How about on the moon? Moon-tides

- Moon also has two tidal bulges, making it a football shape, with long axis pointed towards earth.
- But these bulges do *not* move, because the same side of the moon always faces the earth: moon spins on its axis at the same rate at its orbital motion around earth.

DEMO: you be the moon and try orbiting a fixed friend (earth), always keeping your face towards him/her – you find that you have to spin to do this!

- (Ages ago, it spun much faster, but then slowed down, and got locked into this synchronous orbit because of a torque action from the earth: I won't examine this effect in this course, but it is interesting:

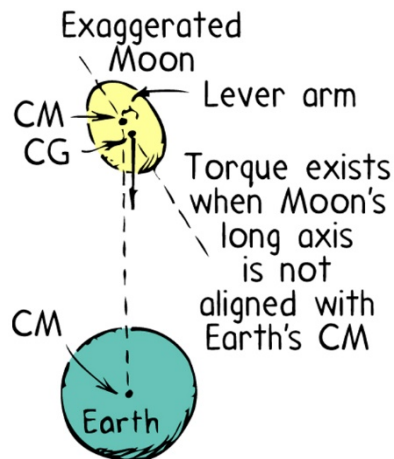

As a result, on earth we only see one side of the moon.)

Gravitational Fields

- Gravitational force acts at a distance – i.e. the objects do not need to touch each other.
- We can regard them as interacting with the *gravitational field* of the other: think of this existing in the space around an object, so another object in this space feels a force towards it.

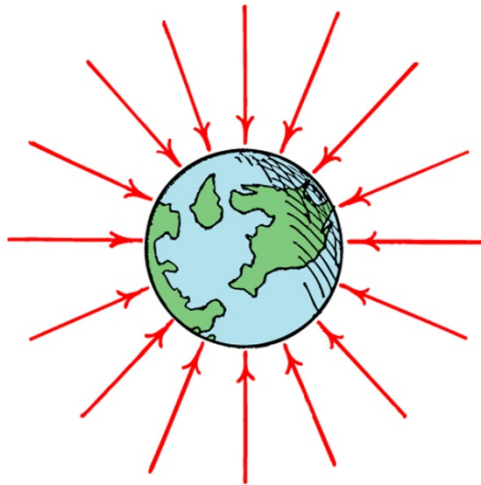

Copyright © 2006 Paul G. Hewitt, printed courtesy of Pearson Education Inc., publishing as Addison Wesley.

Field lines have arrows indicating direction of force at that point, and are closer together when the field is strongest.

The gravitational field is a vector, same direction as the force, and strength is the force on a mass m , divided by that m :

$$g = F/m, \text{ units are N/kg}$$

Gravitational field inside a planet

- We will not cover this in much detail.
- The only thing we will note is that the field increases linearly inside the planet (and falls off in the usual inverse-square way outside). It is zero right in the middle of the planet.

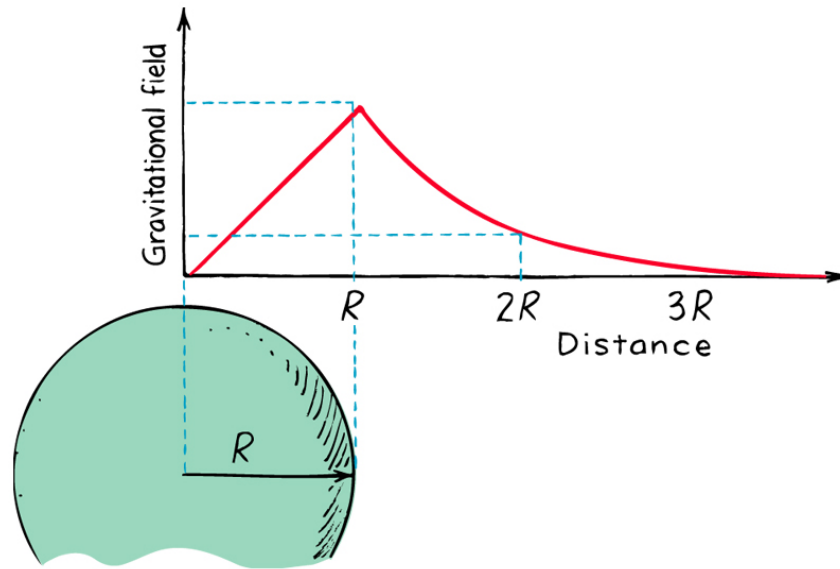

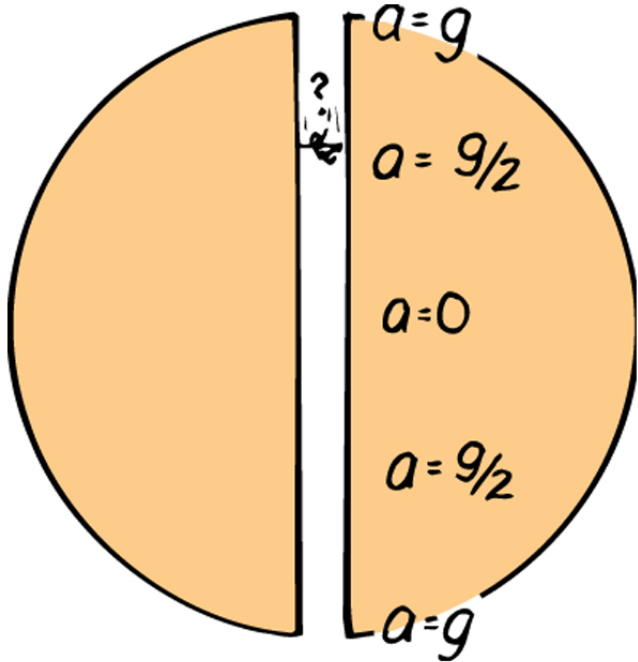

Copyright © 2006 Paul G. Hewitt, printed courtesy of Pearson Education Inc., publishing as Addison Wesley.

Object dropped in hole will execute periodic motion, like a mass on a spring (covered in Ch. 19)

describe motion:
flash video mass on spring

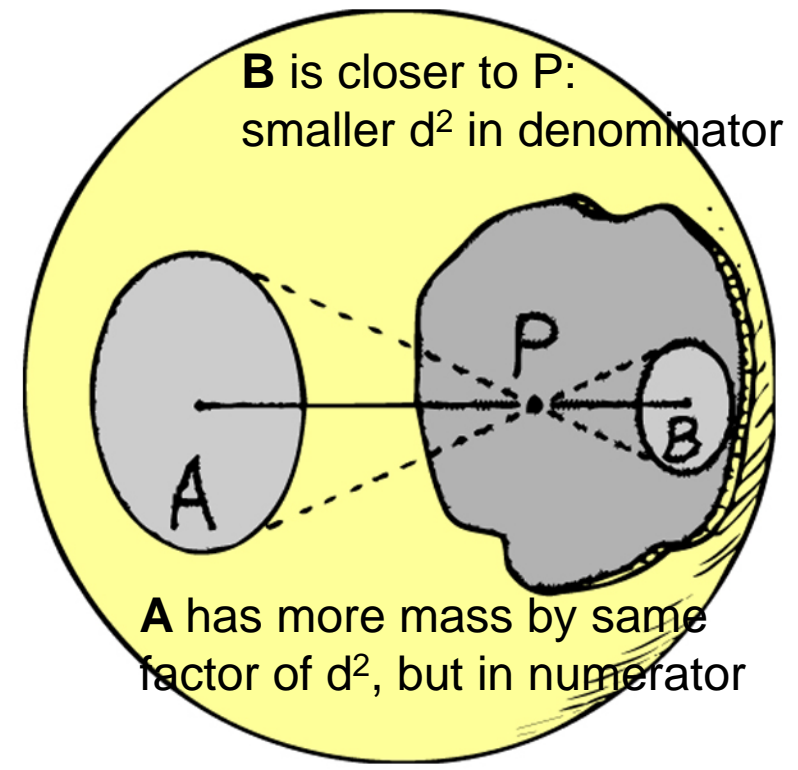

Copyright © 2006 Paul G. Hewitt, printed courtesy of Pearson Education Inc., publishing as Addison Wesley.

Object inside a hollow sphere is weightless.

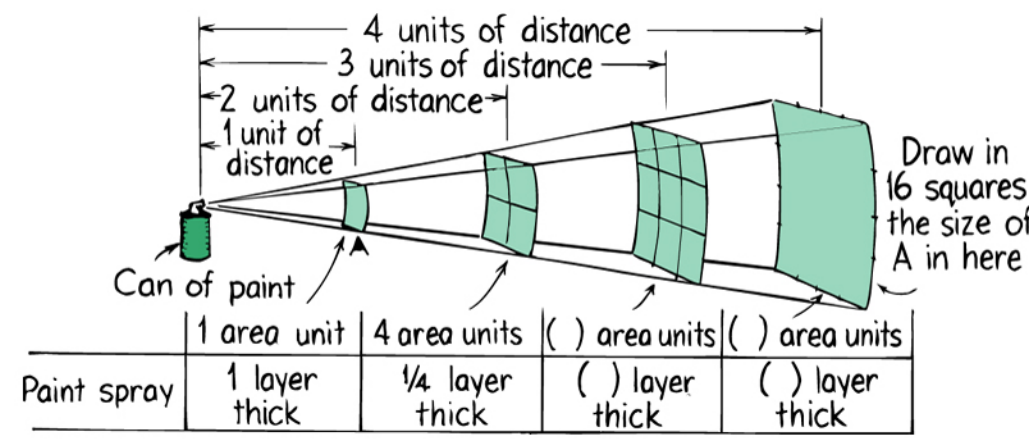

Copyright © 2006 Paul G. Hewitt, printed courtesy of Pearson Education Inc., publishing as Addison Wesley.

A very little on Einstein's Theory of Gravitation

- 1900's: Einstein's theory of general relativity involves **curved four-dimensional space-time**

Replace bodies producing gravitational fields with warped space-time.

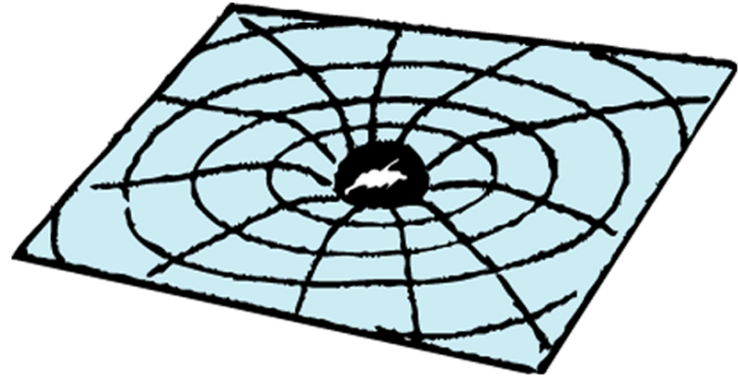

Copyright © 2006 Paul G. Hewitt, printed courtesy of Pearson Education Inc., publishing as Addison Wesley.

Not examinable in this course...

A little on Black Holes

- Because grav. force increases with decreasing distance, then if a massive object somehow shrinks tremendously (keeping amount of mass fixed) the grav. force on its surface gets tremendously stronger.
- Happens for massive stars (> 1.5 of mass of our sun) when they have burnt their fuel – the stuff left condenses into an extremely dense object (neutron star ~ 10 km radius) which, if large enough, continues to shrink because of its gravity. Neutron star has density of $\sim 10^{18}$ kg/m³: 1 teaspoon would weigh 50 billion tons on earth!
- Consider an object on the surface of such a star – it feels increasing grav. force, to the point that it can never leave it.
i.e. the speed required to overcome the grav. force becomes faster than the speed of light, and *no* object can have such a speed. Called a **black hole**.

This means no object, not even light, can escape from a black hole. Anything coming near gets sucked in and destroyed (although its mass, ang mom, charge are preserved)

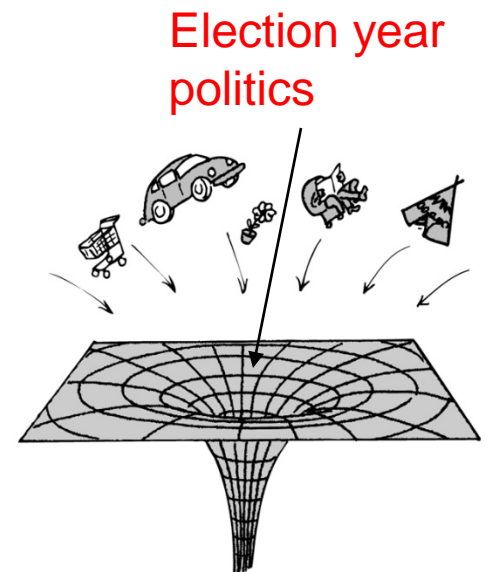

Black holes continued...

- Since black holes are invisible, how do we know they exist?

By their grav. influence on neighboring stars – eg binary star systems, where have one luminous star and a black-hole orbiting each other.

Other experimental evidence indicates massive black holes at the center of many galaxies eg in old ones, stars circle in a huge grav. field, with an “empty-looking” center.

Galactic black holes have masses $10^6 - 10^9$ times that of our sun.

- Related, but still speculative, entity: **wormhole**

Instead of collapsing to a point, it opens out again in another part of the universe – time travel...

But still speculative (unlike black holes)

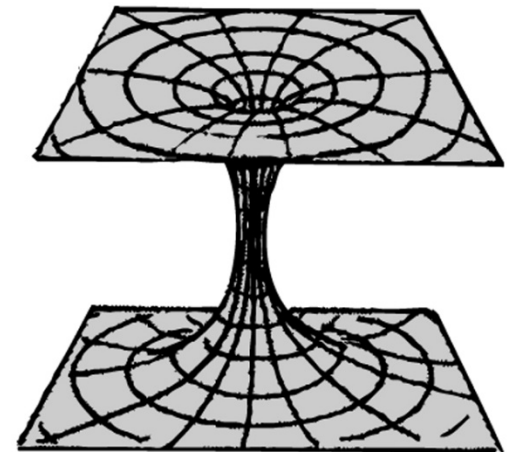

When at rest on the launching pad, the force of gravity on the space shuttle is quite huge—the weight of the shuttle. When in orbit, some 200 km above Earth's surface, the force of gravity on the shuttle is

1. nearly as much.
2. about half as much.
3. nearly zero (micro-gravity).
4. zero.

(Neglect changes in the weight of the fuel carried by the shuttle. By the way, this is a poor approximation: Rockets on the launching pad are typically 80% fuel by weight.)

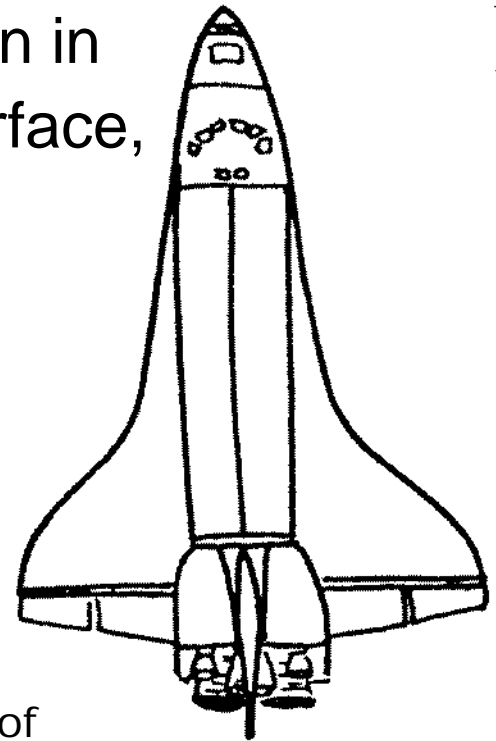

Answer:1, nearly as much

The gravitational force on the shuttle, whether at rest or in orbit, depends on only three things: its mass, the mass of Earth, and its distance from Earth's center. The only variable is distance. On the launching pad the shuttle is about 6370 km from Earth's center. When in orbit it is about 6370 + 200 km from the Earth's center. In accord with $F = GmM / R^2$ the 200-km difference in distance means a 0.06 fractional difference in force. Discounting the changes in the fuel, the gravitational force on the shuttle in orbit is 94% as much as when on Earth's surface—nearly the same.

When at rest on the launching pad, the force of gravity on the space shuttle is quite huge—the weight of the shuttle. When in orbit, some 200 km above Earth's surface, the force of gravity on the shuttle is

- ✓ **1. nearly as much.**
- 2. about half as much.
- 3. nearly zero (micro-gravity).
- 4. zero.

(Neglect changes in the weight of the fuel carried by the shuttle.)

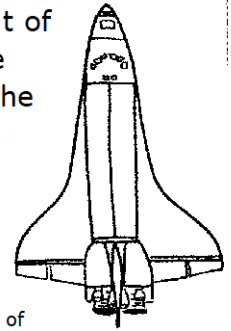

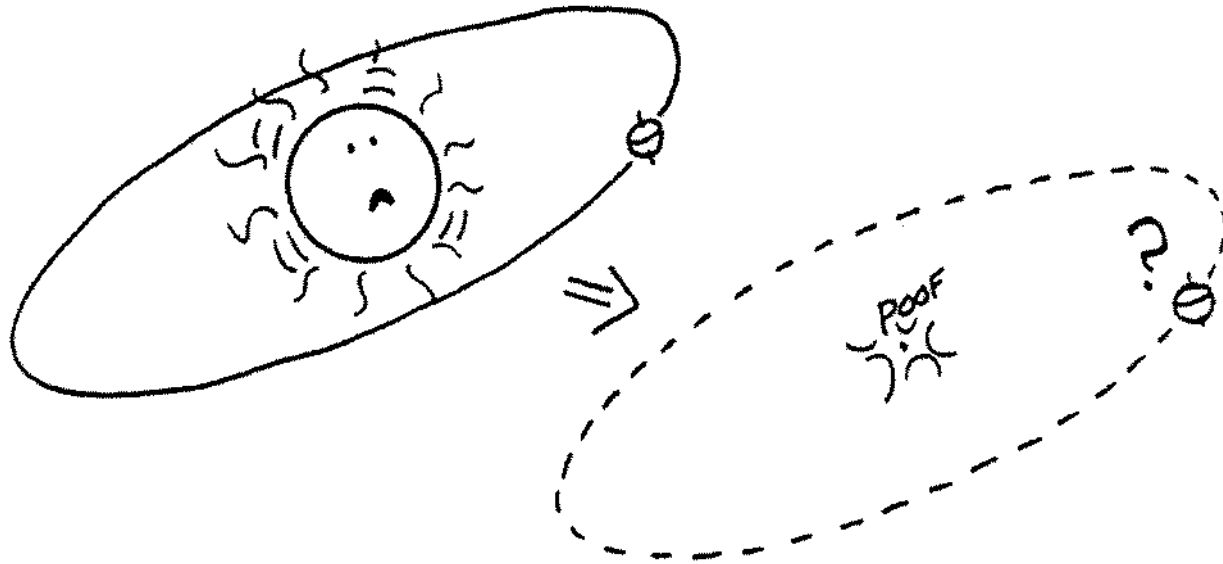

If the Sun suddenly collapsed to become a black hole, the Earth would

1. leave the Solar System in a straight-line path.
2. spiral into the black hole.
3. continue to circle in its usual orbit.

Answer: 3; continue to circle in usual orbit

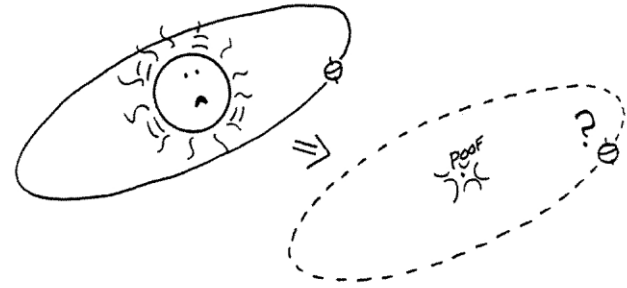

If the Sun suddenly collapsed to become a black hole, the Earth would

1. leave the Solar System in a straight-line path.
2. spiral into the black hole.

3. continue to circle in its usual orbit.

We can see from Newton's equation, $F = G \frac{mM}{d^2}$ that the interaction F between the mass of the Earth and the Sun doesn't change. This is because the mass of the Earth does not change, the mass of the Sun does not change even though it is compressed, and the distance from the centers of the Earth and the Sun, collapsed or not, does not change. Although the Earth would very soon freeze and undergo enormous surface changes, its yearly path would continue as if the Sun were its normal size.



Ocean tides are produced by the Moon. Since our bodies are mostly water, doesn't the Moon similarly produce tides in our bodies?

1. Yes, there are biological tides that affect mood and behavior.
2. Yes, but negligible (less than are produced by an apple you hold over your head).
3. No, because the water in our body isn't free to flow.

Answer: 2, yes, but negligible



Ocean tides are produced by the Moon. Since our bodies are mostly water, doesn't the Moon similarly produce tides in our bodies?

1. Yes, there are biological tides that affect mood and behavior.
- ✓ **2. Yes, but negligible (less than are produced by an apple you hold over your head).**
3. No, because the water in our body isn't free to flow.

Tides are caused by *differences* in gravitational pulls by the Moon (or other celestial bodies) that stretch Earth's oceans. The key to tides is differences in pulls, which is related to differences in distance between various parts of a body and the Moon. Earth's ocean tides are the result of thousands of kilometers difference in distance between near and far parts of the ocean. Scarcely any tides occur in a lake because no part is significantly closer to the Moon than other parts. Likewise for the fluids in your body. You're not tall enough for your head to be appreciably closer to the Moon than your feet. The Moon does produce microtides in your body, however. How strong? Less than an apple held a half meter over your head produces!